

REVISIONS	BY

ARCHITECTURAL DESIGN SERVICE
 LYNDEL D. BANKS

BUILDING SECTIONS

DRAWN: L. BANKS
 CHECKED: OWNER-BUILDER
 DATE: 12 / 25 / 2008
 SCALE: NOTED
 JOB NO.: 10034-BARTSE
 SHEET: S-4

TYPE V CONSTRUCTION NOTES:
 REFER TO TYPE-V SHEET FOR FRAMING GENERAL NOTES.

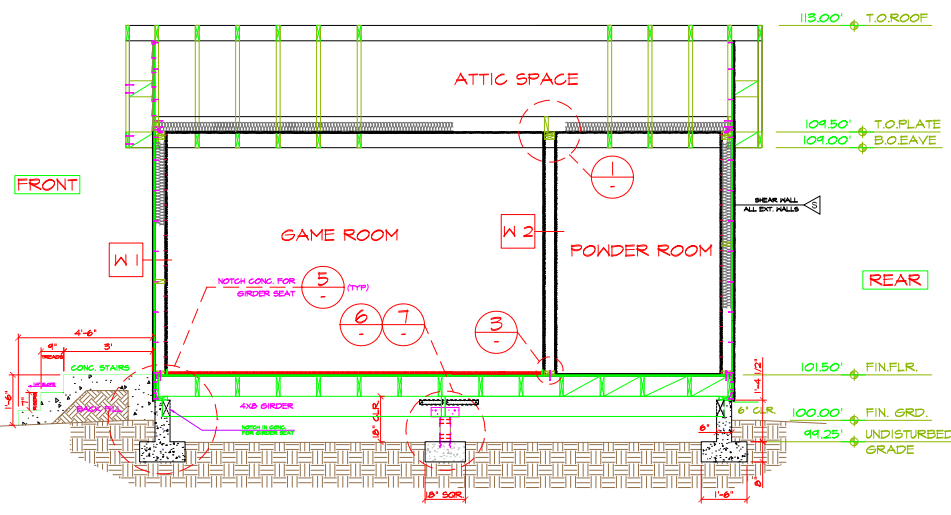

BUILDING SECTION B-B

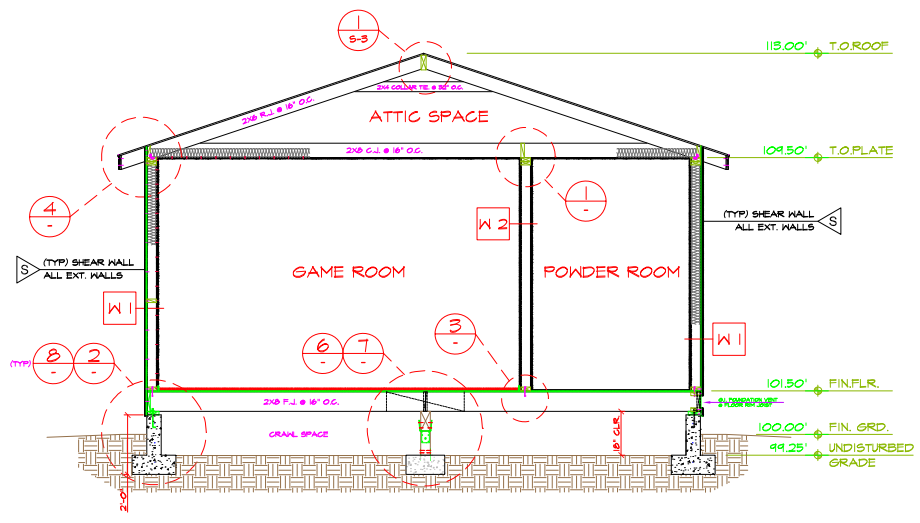

BUILDING SECTION A-A

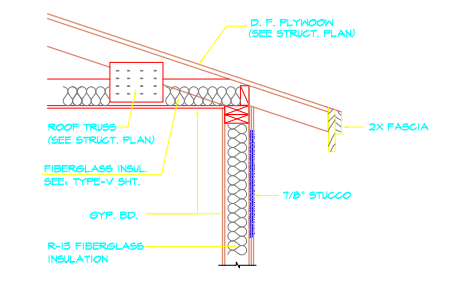

ROOF @ EAVE

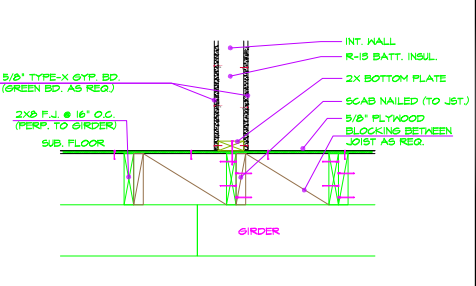

FLOOR @ INT. WALL CONN.

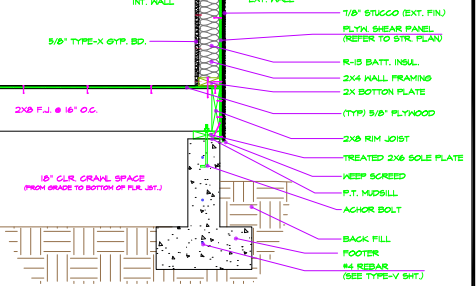

(TYP) FLOOR @ FOUNDATION CONN.

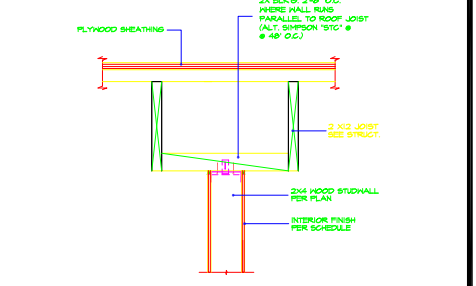

WALL PARALLEL TO JOIST

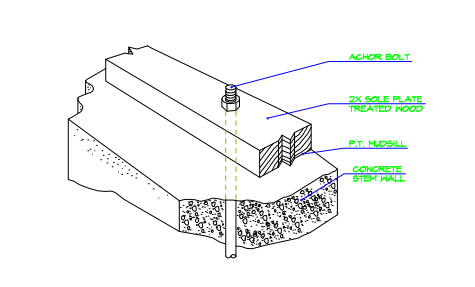

SOLE PLATE @ FOUNDATION

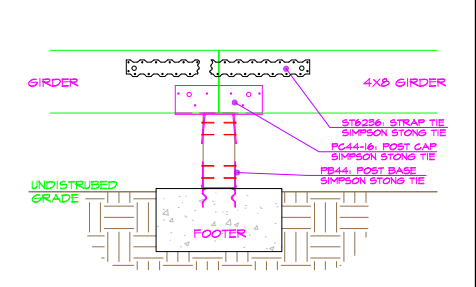

GIRDER/POST CONN. @ FOOTER

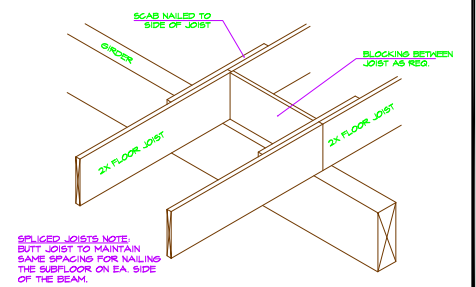

SPLICED JOIST CONN. @ GIRDER

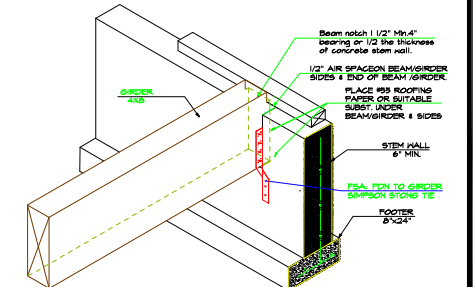

CONC. NOTCH GIRDER SEAT

8

7

6

5

FRONT

113.00' T.O. ROOF

ATTIC SPACE

109.50' T.O. PLATE
109.00' B.O. EAVE

W 1

GAME ROOM

W 2

POWDER ROOM

SHEAR WALL
ALL EXT. WALLS

REAR

NOTCH CONC. FOR GIRDER SEAT 5 (TYP)

6 7

3

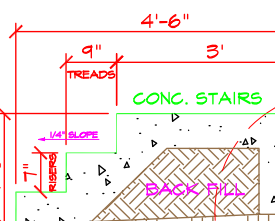

4'-6"

9" TREADS

CONC. STAIRS

BACK FILL

4XB GIRDER

NOTCH IN CONC. FOR GIRDER SEAT

18" CLR.



18" SQR.

1'-4 1/2"

101.50' FIN. FLR.

100.00' FIN. GRD.

99.25' UNDISTURBED GRADE

6" CLR.

1'-6"

8"

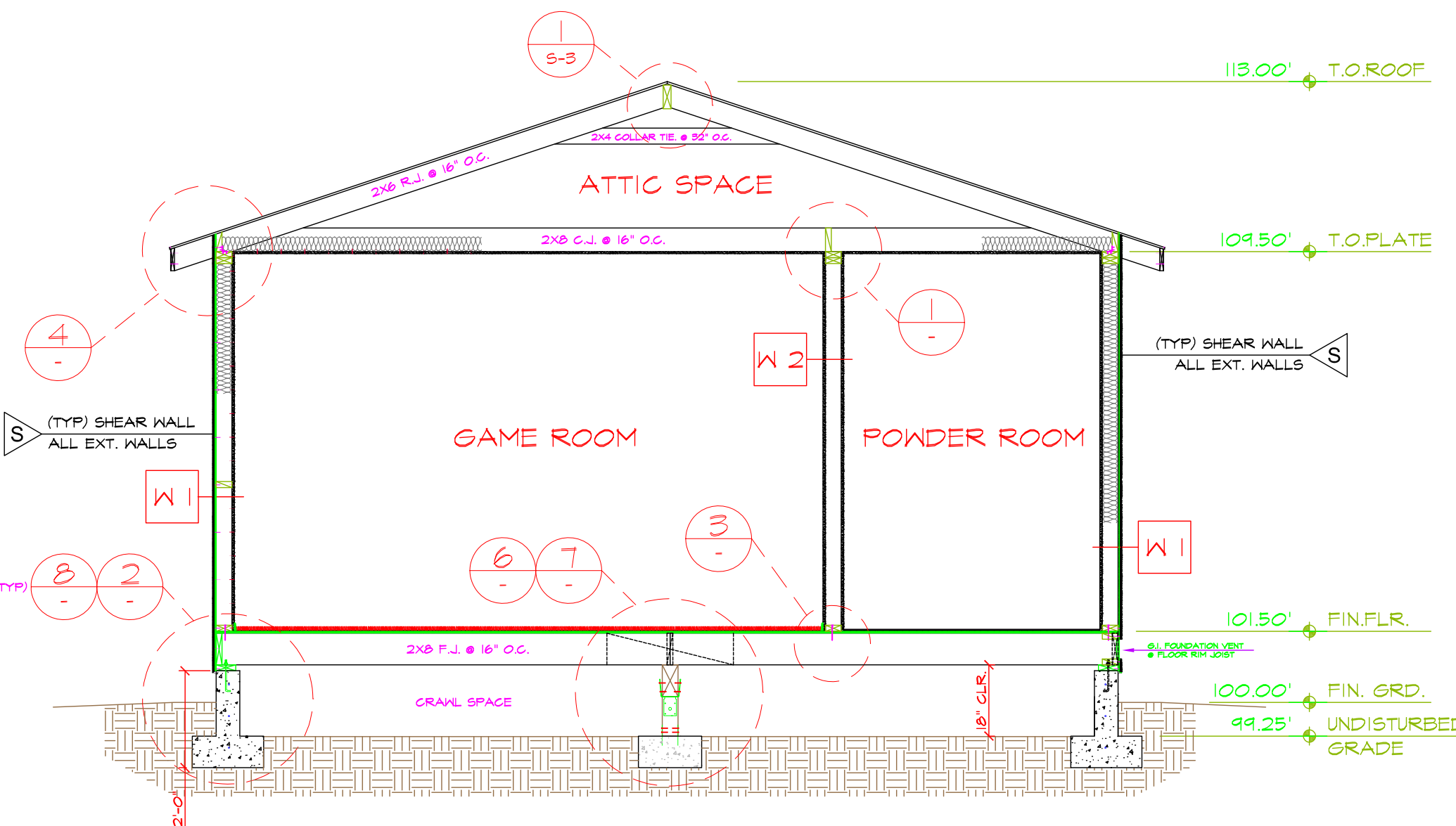

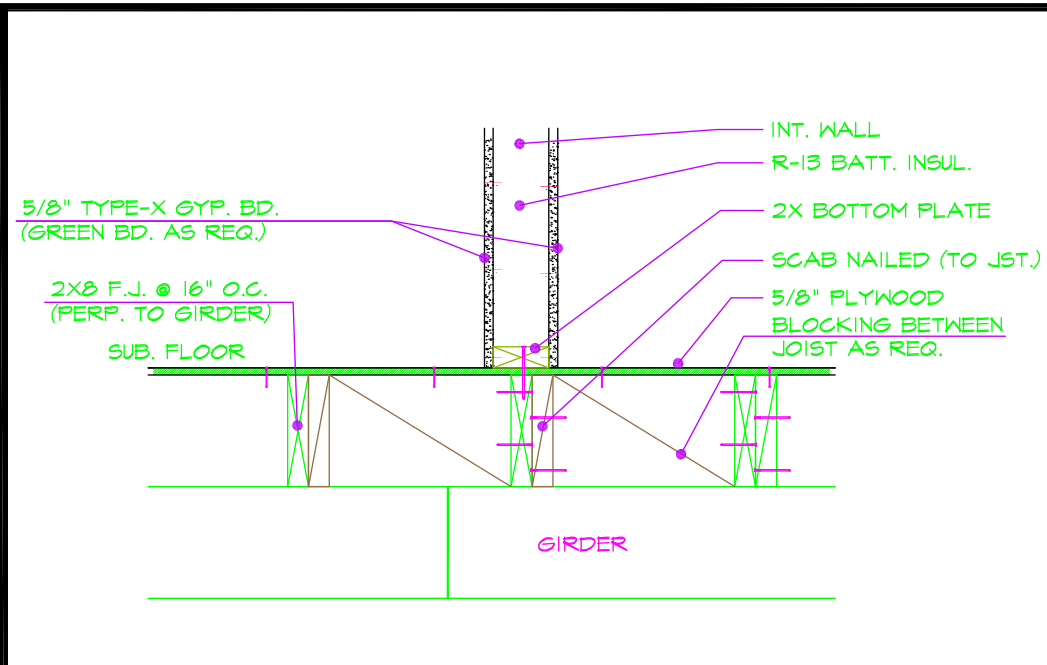

FLOOR @ INT. WALL CONN.

3

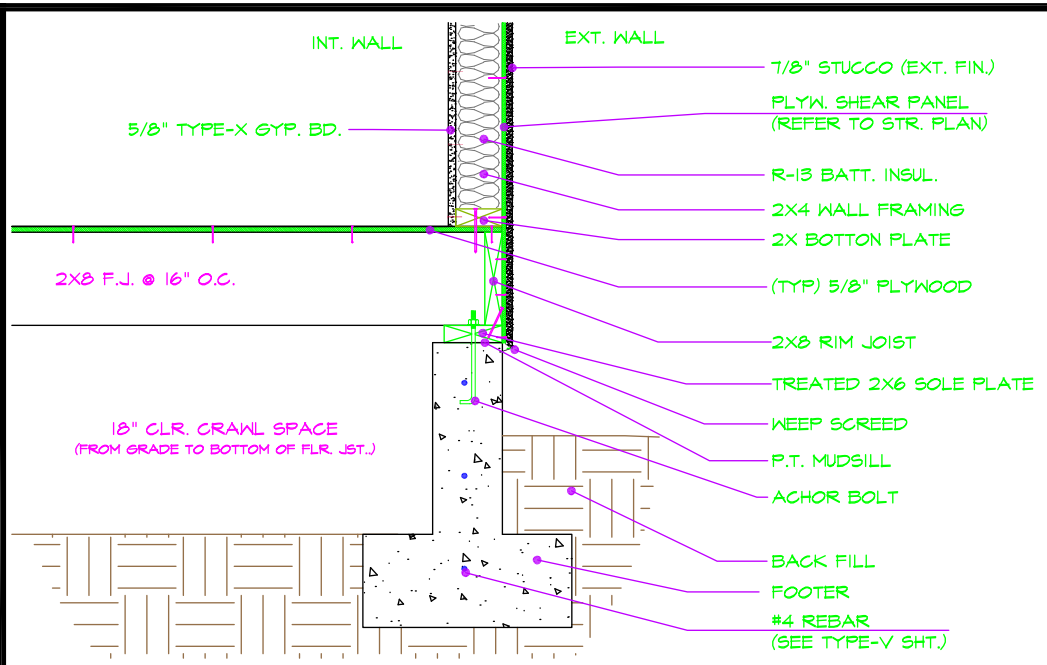

(TYP) FLOOR @ FOUNDATION CONN.

2

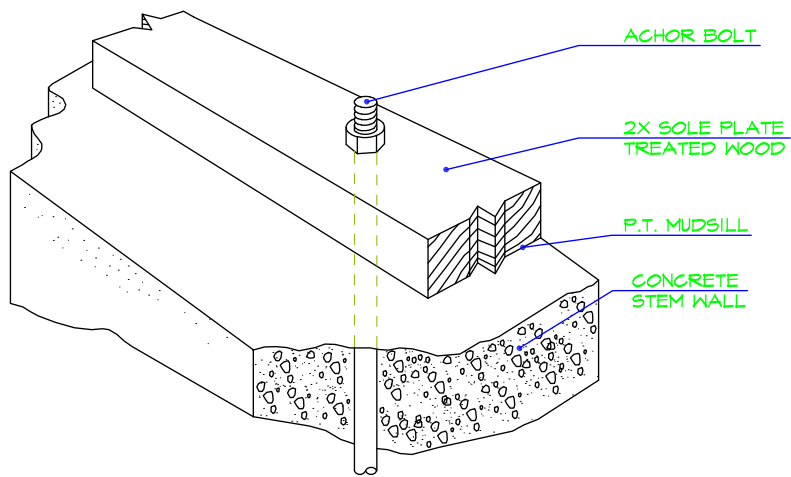

SOLE PLATE @ FOUNDATION

8

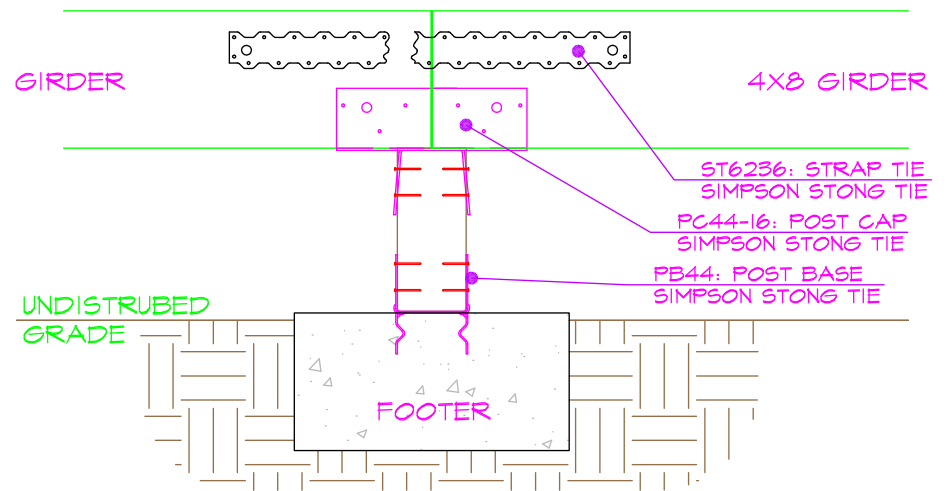

GIRDER/POST CONN. @ FOOTER

7

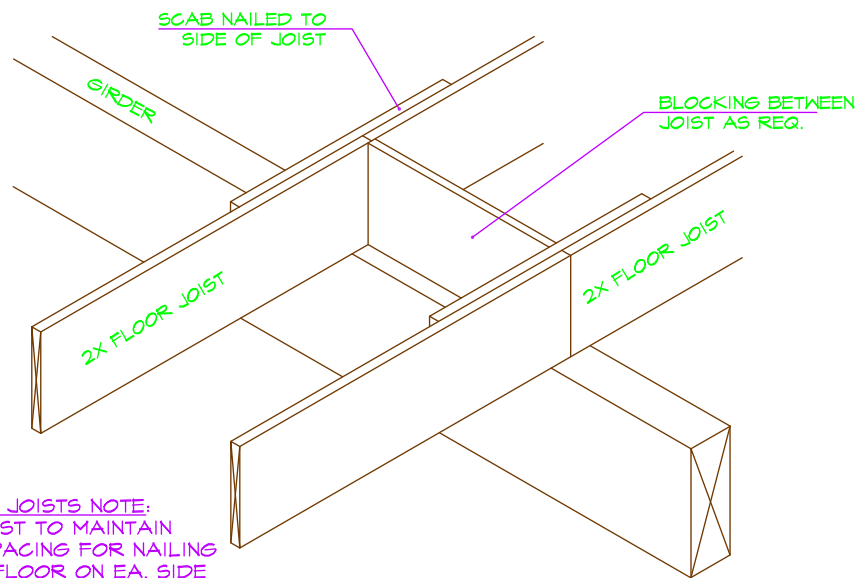

SPLICED JOISTS NOTE:
 BUTT JOIST TO MAINTAIN
 SAME SPACING FOR NAILING
 THE SUBFLOOR ON EA. SIDE
 OF THE BEAM.

SPLICED JOIST CONN. @ GIRDER

6

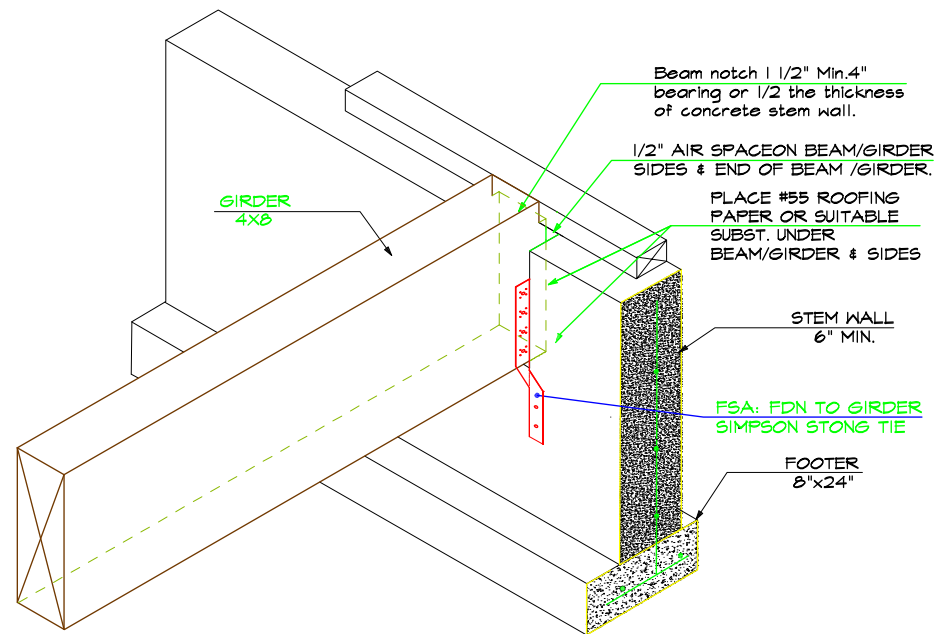

CONC. NOTCH GIRDER SEAT

5

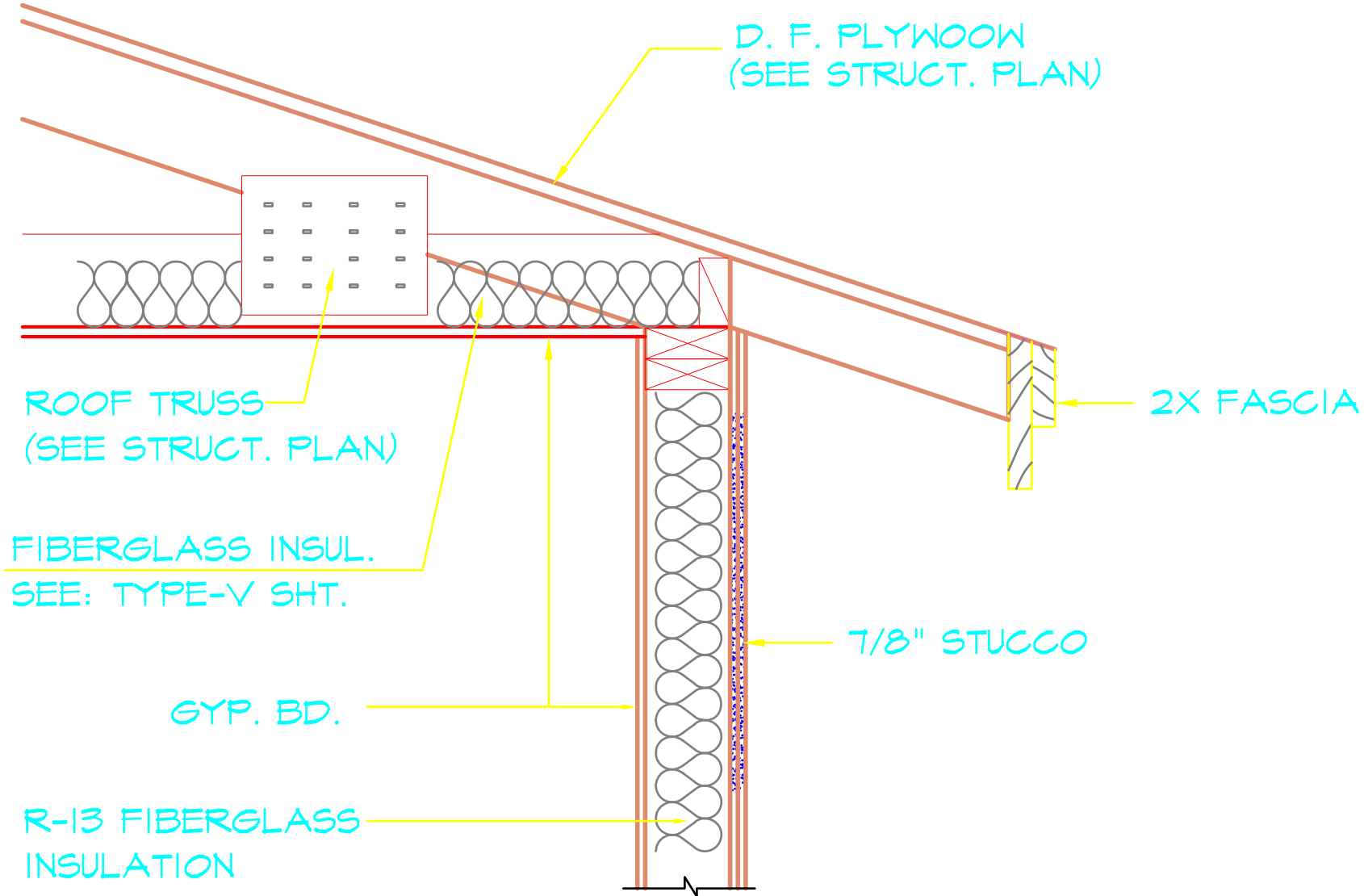

ROOF @ EAVE